

# Data Sheet

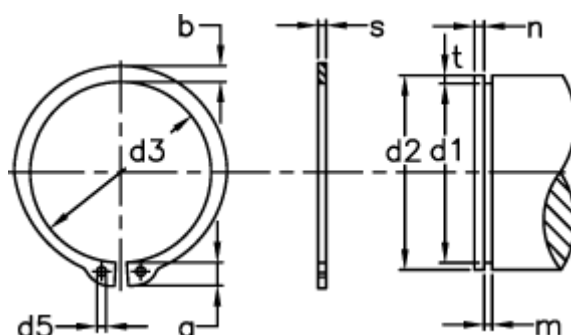

Article number: 0109053  
Description: Retaining ring AS 36x2.5  
Spring steel  
Note: Fitted with ZGA pliers

## Measures



a max	= 6.7	Description	= AS 36	s	= 2.50
AN mm <sup>2</sup>	= 121.0	FN kN	= 20.10	t	= 1.00
B	= 2.04	FRg kN	= 18.3	tol	= -0.25
b	= 4.2	FR kN	= 101.5	tol	= -0.07
d1	= 34.0	g	= 2.0	tol	= +0,25 -0,50
d2	= 36	m min	= 2.65	Tong	= ZGA-3
d3	= 33.2	n abl x 1000	= 16	Weight kg/1000	= 7.50
d5 min	= 2.5	Nominal drive	= 3.3		